

BULMEN



FLOOR SPRING

二维码

WWW.BOMENG.COM

SERIES | 



BM-P-2400

Technical information
 Maximum opening angle: 135°
 Dimension: 320x136x58mm
 Applicable door leaf size: 1500x3000mm
 Applicable door weight: 300kg



BM-G-220B

Can be lifted up and down

Technical information
 Maximum opening angle: 135°
 Dimension: 270x130x50mm
 Applicable door leaf size: 900x2000mm
 Applicable door weight: 80-100kg



BM-P-1400

Technical information
 Maximum opening angle: 135°
 Dimension: 295x146x58mm
 Applicable door leaf size: 1300x2800mm
 Applicable door weight: 200kg



BM-G-210B

Can be lifted up and down

Technical information
 Maximum opening angle: 135°
 Dimension: 270x130x48mm
 Applicable door leaf size: 800x2000mm
 Applicable door weight: 50-80kg



BM-G-1688

Technical information
 Maximum opening angle: 135°
 Dimension: 305x120x50mm
 Applicable door leaf size: 1100x2300mm
 Applicable door weight: 80-130kg



BM-G-8300

Can be lifted up and down

Technical information
 Maximum opening angle: 135°
 Dimension: 305x162x55mm
 Applicable door leaf size: 1300x2800mm
 Applicable door weight: 150kg



BM-G-818

Technical information
 Maximum opening angle: 135°
 Dimension: 306x152x50mm
 Applicable door leaf size: 1100x2200mm
 Applicable door weight: 80-125kg



BM-G-7300

Can be lifted up and down

Technical information
 Maximum opening angle: 116°
 Dimension: 293x150x65mm
 Applicable door leaf size: 1200x2600mm
 Applicable door weight: 140kg



BM-G-68 PRISMATIC

Can be lifted up and down

Technical information

Maximum opening angle: 135°
 Dimension: 322x130x40mm
 Applicable door leaf size: 1100x2300mm
 Applicable door weight: 80-135kg



BM-818 PRISMATIC

Technical information

Maximum opening angle: 135°
 Dimension: 306x152x50mm
 Applicable door leaf size: 1000x2100mm
 Applicable door weight: 80-120kg



BM-3388 PRISMATIC

Can be lifted up and down

Technical information

Maximum opening angle: 135°
 Dimension: 306x152x50mm
 Applicable door leaf size: 1000x2100mm
 Applicable door weight: 80-120kg



BM-220B PRISMATIC

Technical information

Maximum opening angle: 135°
 Dimension: 120x270x50mm
 Applicable door leaf size: 800x2000mm
 Applicable door weight: 50-80kg



BM-2388 PRISMATIC

Can be lifted up and down

Technical information

Maximum opening angle: 135°
 Dimension: 270x130x51mm
 Applicable door leaf size: 900x2000mm
 Applicable door weight: 70-100kg



BM-222 PRISMATIC

Technical information

Maximum opening angle: 135°
 Dimension: 306x152x50mm
 Applicable door leaf size: 1000x2100mm
 Applicable door weight: 80-120kg



BM-220A PRISMATIC

Technical information

Maximum opening angle: 135°
 Dimension: 270x130x48mm
 Applicable door leaf size: 800x2000mm
 Applicable door weight: 50-80kg



BM-A-7300 PRISMATIC

Technical information

Maximum opening angle: 135°
 Dimension: 322x130x40mm
 Applicable door leaf size: 1100x2300mm
 Applicable door weight: 140kg

FLOOR SPRING ACCESSORIES SERIES

BM-KLC-101

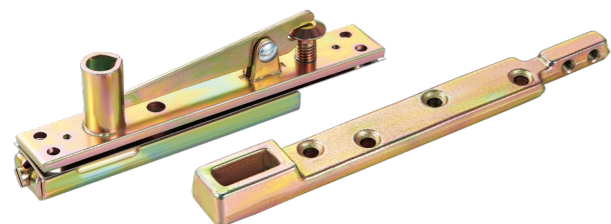

BM-KLC-102

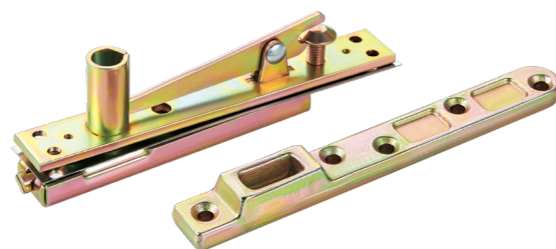

BM-KLC-103

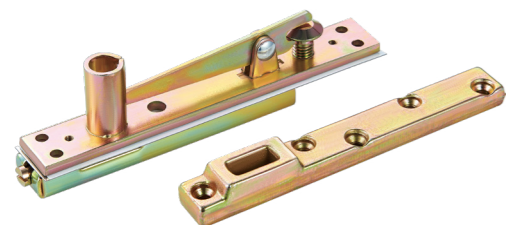

BM-KLC-104

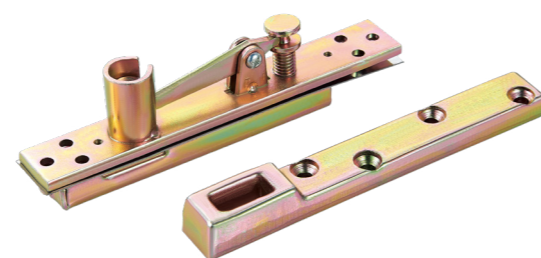

BM-KLC-105

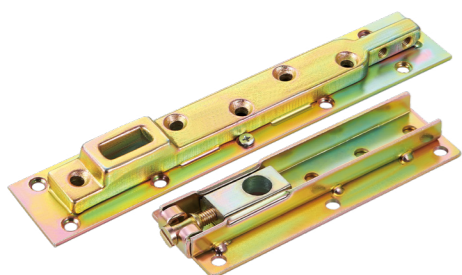

BM-KLC-106

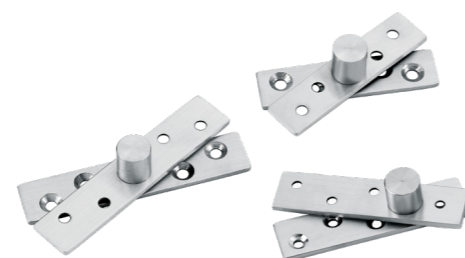

DOOR CLAMP SERIES

BM-KLC-201

Bottom patch fitting

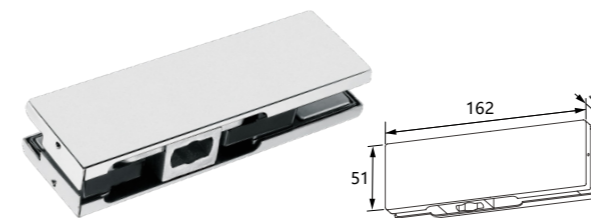

BM-KLC-202

Top patch fitting

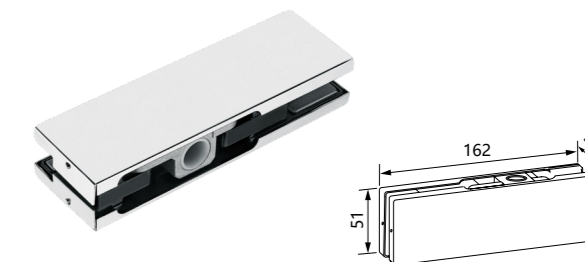

BM-KLC-203

Upper patch fitting

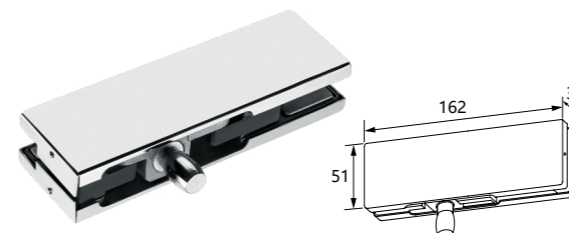

BM-KLC-204

Patch fitting

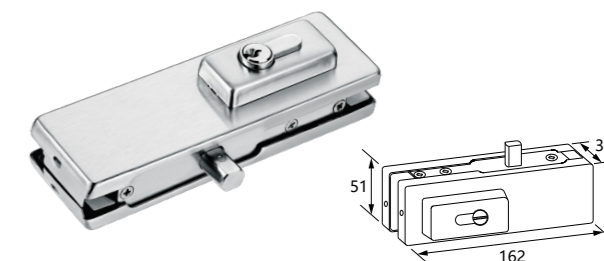

BM-KLC-205

Corner patch fitting

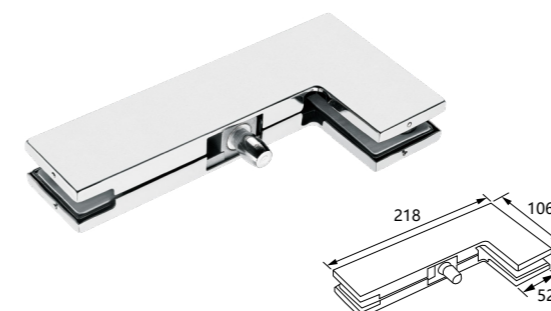

Technical information
 Finishing: Stainless steel/Satin/Mirror/Titanium
 Lock case material: Stainless steel
 Suitable for door thickness: 10-12mm safety glass